

# MK-377EXP TILE SAW OWNER'S MANUAL & PARTS LIST



Part# 160028

Revision 208	12.2021
Manual Part No. 160030	

**Caution:** Read all safety and operating instructions before using this equipment. This parts list **MUST** accompany the equipment at all times.

## INTRODUCTION

Congratulations on your purchase of a MK-377EXP Saw. We are certain that you will be pleased with your purchase. MK Diamond takes pride in producing the finest construction power tools and diamond blades in the industry.

Operated correctly, your MK-377EXP Saw should provide you with years of service. In order to help you, we have included this manual. This owners manual contains information necessary to operate and maintain your MK-377EXP Saw safely and correctly. Please take the time to familiarize yourself with the MK-377EXP Saw by reading and reviewing this manual.

Read and follow all safety, operating and maintenance instructions.

If you should have questions concerning your MK-377EXP Saw, please feel free to call our friendly customer service department at: 800 421-5830

Regards,

MK Diamond

### NOTE THIS INFORMATION FOR FUTURE USE:

<b>MODEL NUMBER:</b>	
<b>SERIAL NUMBER:</b>	
<b>PURCHASE PLACE:</b>	
<b>PURCHASE DATE:</b>	

**WARRANTY:** For your (1) one year warranty to be effective, complete the online Product Registration as soon as possible. Visit [www.mkdiamond.com/registration/](http://www.mkdiamond.com/registration/)

# TABLE OF CONTENTS

## **SAFETY**

Safety Messages	4
Damage Prevention Message	4
General Safety Precautions	4-7
California Proposition 65 Message	8
Electrical Requirements and Grounding Instructions	9
Electric Motor Safety	10-12
Safety Label Locations	13
Product Specifications	14

## **UNPACKING, TRANSPORT**

Unpacking	15
Contents	15
Transport	15

## **STARTUP, ADJUSTMENT, OPERATION and SHUTDOWN**

Cutting Head Installation	16
Diamond Blade Installation	16-17
Adjustable Cutting Guide Installation	18
Splash Guard Installation	18
Pre-Start Inspection	18
Water Pump Preparation	19
Setup for Operation	20
Adjustment & Operation	21
Cleanup	22-23
Lockout	23

## **MAINTENANCE AND TROUBLESHOOTING**

Maintenance	23-24
Blade Dressing	24
Motor Brush Change Out	25
Troubleshooting	26-28

## **EXPLODED VIEW AND PARTS LIST**

Exploded View & Parts List	30-33
----------------------------	-------

## **ACCESSORIES ORDERING and RETURN INSTRUCTIONS**

Accessories	34
Ordering Information	36
Return Material Policy	36
Packaging Instructions	36
Authorized Service Centers	36
Contact & Warranty	37

Read and follow all safety, operating and maintenance instructions. Failure to read and follow these instructions could result in injury or death to you or others. Failure to read and follow these instructions could also result in damage and/or reduced equipment life. Safety warnings and guidelines do not by themselves eliminate danger. They are not substitutes for proper accident prevention procedures and good judgement.

## SAFETY MESSAGES

A safety message alerts you to potential hazards that could hurt you or others. Each safety message is preceded by a safety alert symbol (  ) and one of three words: **DANGER**, **WARNING**, or **CAUTION**.



**DANGER** You **WILL** be **KILLED** or **SERIOUSLY INJURED** if you **DO NOT** follow directions.



**WARNING** You **CAN** be **KILLED** or **SERIOUSLY INJURED** if you **DO NOT** follow directions.



**CAUTION** You **CAN** be **INJURED** if you **DO NOT** follow directions. It may also be used to alert against unsafe practices.

## DAMAGE PREVENTION AND INFORMATION MESSAGES

A Damage Prevention Message is to inform the user of important information and/or instructions that could lead to equipment or other property damage if not followed. Information Messages convey information that pertains to the equipment being used. Each message will be preceded by the word **NOTE**, as in the example below.

**NOTE:** Equipment and/or property damage may result if these instructions are not followed.

## GENERAL SAFETY PRECAUTIONS AND HAZARD SYMBOLS

In order to prevent injury, the following safety precautions and symbols should be followed at all times!



**ALWAYS** read this Owner's Manual before operating the machine. **DO NOT** operate or service this equipment before reading this entire manual. Read and understand all warnings, instructions and controls on the machine. Know how to stop the equipment quickly in case of emergency. It is the operators responsibility to use this machine under safe working conditions and conform with federal, state and local codes or regulations pertaining to safety, air, pollution, noise etc...



**ALWAYS** keep the Blade and Belt Guards in place. **DO NOT** operate this machine with any guard or safety device removed. A Guard, or any damaged part should be repaired or replaced immediately.



**NEVER** operate this equipment without proper protective clothing, shatterproof glasses, steel-toed boots and other protective devices required by the job. Non-slip foot wear is recommended.

**PERSONAL PROTECTIVE EQUIPMENT**

**ALWAYS** wear approved respiratory, head, ear and eye protection when operating this machine.

**ACCIDENTAL STARTS!**

Before starting the engine/motor, be sure the **ON/OFF** switch is in the **OFF** position to prevent accidental starting. Place the **ON/OFF** switch in the **OFF** position before performing any service operation. **ALWAYS** place the power **ON/OFF** switch in the **OFF** position when the machine is not in use.

**ROTATING PARTS**

Keep hands, feet, hair, and clothing away from all moving parts to prevent injury. Never operate the motor with covers, shrouds, or guards, removed.

**HOT PARTS!**

Engine components can become extremely hot from operation. To prevent severe burns, do not touch these areas while the engine is running, or immediately after it is turned off. Never operate the engine with heat shields removed.

**OVER SPEED**

**NEVER** tamper with the governor components or settings to increase the maximum speed. Severe personal injury and damage to the engine or equipment can result if operated at speeds above maximum.

**ELECTRICAL SHOCK**

**NEVER** touch electrical wires or components while the engine is running. Exposed, frayed or worn electrical wiring and plugs can be sources of electrical shock which could cause severe injury or burns. Do not touch the plug with wet hands.



**ALWAYS** avoid inhalation of and skin contact with silica dust and/or mist. Provide proper dust removal. Use dust-collection system when applicable.



**NEVER** operate the machine in an explosive atmosphere or near combustible materials. Sparks from the cutting-action of this machine can ignite flammable materials, liquids, gases or dust.



This equipment should not be operated by persons under 18 years of age.

**KEEP CHILDREN AWAY**

All visitors and children should be kept a safe distance from work area. Maintain a safe operating distance to other personnel.

**MAKE THE WORKSHOP KID PROOF**

Make the workshops kid proof by using padlocks, master switches or by removing starter keys.

**DO NOT FORCE THE TOOL**

A power tool will do a job better and safer operating at the rate for which it was designed. **DO NOT** force a tool or an attachment to do a job that it was not designed to do.

**USE PROPER APPAREL**

**DO NOT** wear loose clothing, gloves, neckties, rings, bracelets, or other jewelry that may be caught in moving parts. Non-slip footwear is recommended. Wear protective hair covering to contain long hair.

**SECURE WORK**

Clamps or a vise should be used to hold work whenever practical. Keeping your hands free to operate a power tool is safer.

**DO NOT OVERREACH**

Keep proper footing and balance at all times by not overreaching.

**DISCONNECT TOOLS**

Power tools should always be disconnected before servicing, adjusting or when changing accessories, such as blades, bits, cutters, and the like.

**MAINTAIN TOOLS WITH CARE**

Keep tools clean and maintained for the best and safest performance. Always follow maintenance instructions and examine the machine before use. If any abnormal vibrations or noises occurs, turn off machine immediately and have the problem corrected before further use.

**REMOVE ADJUSTING KEYS AND WRENCHES**

Form a habit of checking to see that keys and adjusting wrenches are removed from the power tool before it is turned on.

**KEEP WORK AREA CLEAN**

Cluttered work areas and benches invite accidents. Keep area around machine clear of obstructions which could cause persons to fall.

**DO NOT USE IN DANGEROUS PLACES**

**DO NOT** operate equipment in dangerous or hazardous environments. **DO NOT** use power tools in damp or wet locations nor expose them to rain. Always keep the work area well lighted.

**USE RECOMMENDED ACCESSORIES**

Consult the owner's manual for recommended accessories. Using improper accessories may increase the risk of personal or by-stander injury. Unauthorized equipment modifications will void all warranties. Manufacturer does not assume responsibility for any accident due to equipment modifications.



**ALWAYS** ensure that the machine is on level ground before using.

**NEVER STAND ON THE TOOL**

Serious injury could occur if a power tool is tipped, or if a cutting tool is unintentionally contacted.

**TRANSPORT**

When loading or unloading the machine, use caution. Remove the blade prior to hoisting, loading and transporting the machine.

**CHECK FOR DAMAGED PARTS**

Before using a power tool, check for damaged parts. A guard or any other part that is damaged should be carefully checked to determine if it would operate properly and perform its intended function. Always check moving parts for proper alignment or binding. Check for broken parts and mountings and all other conditions that may affect the operation of the power tool. A guard, or any damaged part, should be properly repaired or replaced. Always check the machine for loose bolts before starting.

**DIRECTION OF ROTATION**

A blade or cutter should always be installed so that rotation is in the direction of the arrow imprinted on the side of the blade or cutter. It should correspond with the rotational direction of the motor. Always feed work into a blade against the direction of rotation.

**NEVER LEAVE A TOOL UNATTENDED**

**TURN POWER OFF** - Do not leave a tool until it comes to a complete stop. **ALWAYS** turn a power tool **OFF** when leaving the work area, or, when a cut is finished.



**NEVER** disconnect any "emergency or safety devices". These devices are intended for operator safety. Disconnection of these devices can cause severe injury, bodily harm, or even death! Disconnection of any of these devices will void all warranties. Unauthorized equipment modifications will void all warranties. Manufacturer does not assume responsibility for any accident due to equipment modifications.



**NEVER** use this machine with any cutter designed for woodworking.



**NEVER** operate this equipment when not feeling well due to fatigue, illness or taking medicine.



**NEVER** operate this equipment under the influence of drugs or alcohol.



On belt driven equipment, overtensioning of belts will result in premature crank and/or bearing failure.



Whenever necessary, replace nameplate, operation and safety decals when they become difficult to read.



**ALWAYS** store equipment properly when it is not being used. Equipment should be stored in a clean, dry location out of the reach of children



**DO NOT** lend or rent this equipment without including the Owner's Manual and the Engine/Motor Manufacturer's Manual.



Check the chemical properties of the material to be cut/grinded and follow all EPA/OSHA Regulations. (cut/ground)

## **SILICA DUST WARNING**

---

Grinding/cutting/drilling of masonry, concrete, metal and other materials with silica in their composition may give off dust or mists containing crystalline silica. Silica is a basic component of sand, quartz, brick clay, granite and numerous other minerals and rocks. Repeated and/or substantial inhalation of airborne crystalline silica can cause serious or fatal respiratory diseases, including silicosis. In addition, California and some other authorities have listed respirable crystalline silica as a substance known to cause cancer. When cutting such materials, always follow respiratory precautions.

Use appropriate NIOSH-approved respiratory protection where dust hazard may occur. Paper masks or surgical masks without a NIOSH approval number are not recommended because they do little to protect the worker. For more information about respirator programs, including what respirators have received NIOSH approval as safe and effective, please visit the NIOSH website at:

<http://www.cdc.gov/niosh/topics/respirators>

Observe OSHA regulations for respirator use (29 C.F.R. §1910.134).

Visit <http://www.osha.gov> for more information.

## **CALIFORNIA PROPOSITION 65 MESSAGE**

---

Some dust created by power sanding, sawing, grinding, drilling, and other construction activities contain chemicals known (to the State of California) to cause cancer, birth defects or other reproductive harm. Some examples of these chemicals are:

- Lead, from lead-based paints
- Crystalline silica, from bricks and cement and other masonry products
- Arsenic and chromium, from chemically treated lumber

For further information, consult the following sources:

<http://www.osha.gov/dsg/topics/silicacrystalline/index.html>

<http://www.cdc.gov/niosh/docs/96-112/>

<http://oehha.ca.gov/prop65/law/P65law72003.html>

<http://www.dir.ca.gov/Title8/sub4.html>

<http://www.P65warnings.ca.gov>

Your risk from these exposures varies depending on how often you do this type of work. To reduce your exposure to these chemicals, work in a well-ventilated area, and work with approved safety equipment, such as dust masks that are specially designed to filter out microscopic particles. Where use of a dust extraction device is possible, it should be used. To achieve a high level of dust collection, use an industrial HEPA vacuum cleaner. Observe OSHA 29 CFR part 1926.57 and 1926.103.



## ELECTRICAL REQUIREMENTS AND GROUNDING INSTRUCTIONS

In order to prevent electrical shock and injury, the following electrical safety precautions and symbols should be followed at all times!



### WARNING

In case of a malfunction or breakdown, grounding provides a path of least resistance for electrical current to reduce the risk of electric shock. This tool is equipped with an electric cord which has an equipment-grounding conductor and a grounding plug. The plug must be plugged into a matching outlet that is properly installed and grounded in accordance with all local codes and ordinances.

- **DO NOT** modify the plug provided - if it will not fit the outlet, have the proper outlet installed by a qualified electrician.
- Improper connections of the equipment-grounding conductor can result in a risk of electric shock. The equipment-grounding conductor is the insulated conductor that has an outer surface that is green, with or without yellow stripes. If repair or replacement of the electric cord or plug is necessary, **DO NOT** connect the equipment-grounding conductor to a live terminal.
- Check with a qualified electrician or service personnel if the grounding instructions are not completely understood, or if in doubt as to whether the tool is properly grounded.
- Use only 3-wire extension cords that have 3-prong grounding plugs and 3-pole receptacles that accept the tool's plug.
- Repair or replace a damaged or worn cord immediately.

This tool is intended for use on a circuit that has an outlet that looks like the one shown in Sketch A. The tool has a grounding plug that looks like the plug illustrated in Sketch A. A temporary adapter, which looks like the adapter illustrated in sketches B and C, may be used to connect this plug to a 2-pole receptacle as shown in Sketch B, if a properly grounded outlet is not available. The temporary adapter should be used only until a properly grounded outlet can be installed by a qualified electrician. The green-colored rigid ear, plug, and the like, extending from the adapter, must be connected to a permanent ground, such as a properly grounded outlet box.

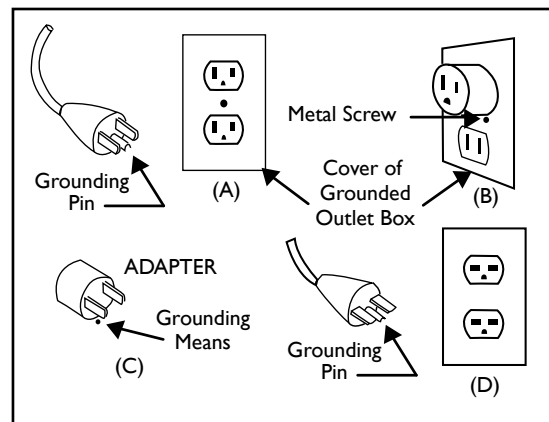

Circuit and Adapter Information

**NOTE:** Use of a temporary adapter is not permitted in Canada.

**NOTE:** If permanently connected this tool should be connected to a grounded metal permanent wiring system; or to a system having an equipment - grounding conductor.

## ELECTRIC MOTOR SAFETY

---

For maintenance care and operation of the electric motor, refer to your electric motor instruction booklet furnished with the electric motor. Protect the electric motor from dust as much as possible and keep ventilating openings clean. Before plugging in the machine, make sure that the outlet voltage is within the voltage marked on the machines's data plate.



### CAUTION



**DO NOT** spray water on the electric motor. **DO NOT** touch the plug with wet hands. To reduce the risk of electrocution, keep all connections dry and off the ground.



**DO NOT** operate electric motor in an explosive environment.



### DO NOT EXPOSE TO RAIN

**DO NOT** expose to rain or use in damp locations.



### WARNING



If operating the equipment in damp locations is unavoidable, **ALWAYS** use a Ground Fault Circuit Interrupter, **ALWAYS** wear rubber gloves and footwear in damp conditions.



**DO NOT** abuse the cord. Never use the cord to carry the equipment or to pull the plug from the outlet. Keep the cord away from heat, sharp edges, and moving parts. Replace damaged cords immediately. Damaged cords increase the risk of electric shock.



### WARNING

To reduce the risk of electrocution, keep all connections dry and off the ground. A Ground Fault Circuit Interrupter (GFCI) should be provided on the circuit(s) or outlet(s) to be used for this machine. Receptacles are available having built-in GFCI protections and may be used for this measure of safety. When using an extension cord, GFCI should be installed closest to the power source, followed by the extension cord and lastly, the machine.



### WARNING

The water pump requires a GFCI. To reduce risk of electrical shock when operating the machine with the pump plugged into the 3-pole receptacle on the motor, connect the machine to a GFCI outlet. See the pump manual and informational tags enclosed separately for all pump information.

**WARNING**

To avoid the possibility of the appliance or plug receptacle getting wet, position the machine to one side of a wall mounted receptacle. This will prevent water from dripping into the receptacle or plug. A "drip loop," shown in the picture below, should be arranged by the user to properly position the power cord relative to the power source. Use the drip loop as a way to prevent GFCI and plug from getting wet.

The "drip loop" is that part of the cord below the level of the receptacle (or the connector, if an extension cord is used). This method of positioning the cord prevents the travel of water along the power cord and coming in contact with the receptacle.

If the plug or receptacle gets wet, **DO NOT** unplug the cord. Disconnect the fuse or circuit breaker that supplies power to the tool. Then unplug and examine for presence of water in the receptacle.

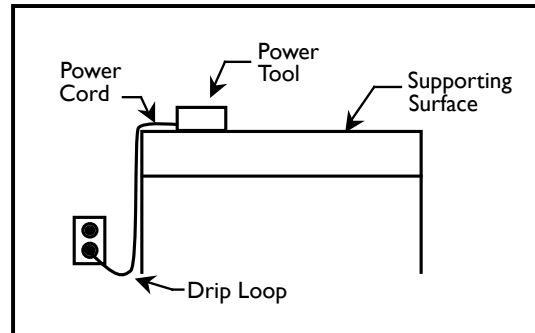

Drip Loop Information

**WARNING**

Use only extension cords that are intended for outdoor use. These extension cords are identified by a marking "Acceptable for use with outdoor appliances; store indoors while not in use." Use only extension cords having an electrical rating not less than the rating of the product. **DO NOT** use damaged extension cords. Examine extension cords before using and replace if damaged. **DO NOT** abuse extension cords and **DO NOT** yank on any cord to disconnect. Keep cords away from heat and sharp edges. Always disconnect the extension cord from the receptacle before disconnecting the product from the extension cord.

**ALWAYS** make certain that the power source required for the electric motor is correct and always use the correct NEMA configuration plug. Motors can burn out when the line voltage falls 10% below the voltage rating of the motor. Failure to use proper voltage will cause the motor to overheat. Make certain that the correct size grounded (3-wires) extension cord is used.

**WARNING**

Use of undersized extension cords result in low voltage to the motor that can result in motor burnout and premature failure. MK Diamond warns that equipment returned to us showing signs of being run in a low voltage condition, through the use of undersized extension cords, will be repaired or replaced totally at the customer's expense. There will be no warranty claim.

To choose the proper extension cord,

- Locate the length of extension cord needed in the table below.
- Once the proper length is found obtain the correct AWG size required for that length of extension cord.

MOTOR SPECS			EXTENSION CORD LENGTH			
Motor	Voltage	Amps	25'	50'	100'	200'
157226-G	120V 1 Ph	5	18 ga	14 ga	12 ga	8 ga

**SAFETY LABEL LOCATIONS**

Safety labels contain important safety information. Please read the information contained on each safety label. These labels are considered a permanent part of your saw. If a label comes off or becomes hard to read, contact MK Diamond or your dealer for a replacement.



Part # 164202

**A**

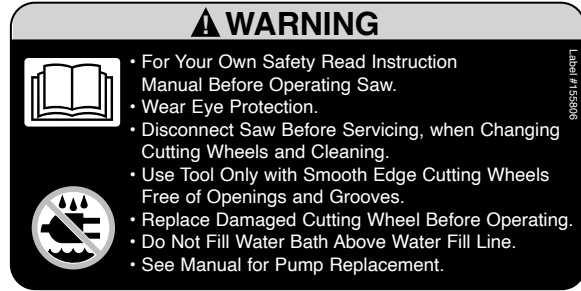

Part # 155806

**B**

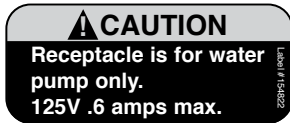

Part # 154822

**C**



Part # 155678

**D**



Part # 170480

**E**



Part # 172640

**F**

Decal/Label	Location	Description
A	Tray - Front	Warning - Dust Control
B	Motor - Top	Warning - Read and Follow Operating Instructions
C	Motor - Top	Caution - Receptacle for water pump
D	Motor - Top	Caution - Use with GFCI only
E	Motor - Front	QR Codes for Manuals and Safety
F	Motor - Front	Warning - Silica Prop 65

## PRODUCT SPECIFICATIONS

---

The MK-377EXP is a versatile Tile Saw. Operated and used according to this manual, the MK-377EXP will provide years of dependable service.

### General Description

---

The MK-377EXP Tile Saw is engineered as a tabletop wet tile saw. The saw includes a powerful 120V electric motor. The saw is capable of cutting tile up to eighteen (18) inches in length. The saw can cut an object two (2) inches thick in one pass.

### Motor Specifications

---

Motor specifications for the MK-377EXP are listed in the table below.

Voltage	120v
Motor Amperage	5
Frequency	50/60Hz
RPM	5500 rpm
Horse Power	1/2 hp

### Blade Capacity

---

The MK-377EXP uses a seven (7) inch (178mm) diameter, wet cutting continuous rim, MK Diamond blade with a five-eighths (5/8) inch (15.875 mm) arbor.

### Tile Types

---

The MK-377EXP can cut a variety of tile types including stone, ceramic, slate, granite, marble, porcelain, and lapidary products.

**NOTE:** The MK-377EXP is not designed to cut plastic or metals.

## TILE SAW SPECIFIC WARNINGS

---

### WARNING

Wear eye protection.

Use splash guard for every operation for which it can be used.

Disconnect saw before servicing, when changing cutting blades, and cleaning.

Replace damaged cutting blade before operating.

**UNPACKING**

**CAUTION** Use proper lifting techniques when lifting the MK-377EXP

Remove the MK-377EXP and accessory box from the carton.

**CONTENTS** One (1) MK-377EXP cutting surface & water pan  
 One (1) MK-377EXP cutting head  
 One (1) 7-inch wet cutting blade  
 One (1) splash guard  
 One (1) blade nut wrench  
 One (1) extended rip guide  
 One (1) electric water pump  
 One (1) cooling transfer tube  
 One (1) flow adjusting clamp  
 One (1) shaft wrench  
 One (1) owners manual  
 One (1) pump manual  
 One (1) warranty card



MK-377EXP  
Pan & Frame



MK-377EXP  
Cutting Head



Diamond Blade



Splash Guard



Blade Nut  
Wrench



Rip Guide



Electric  
Water Pump



Cooling  
Transfer Tube



Flow  
Adjusting Clamp



Shaft  
Wrench



Owner's  
Manual



Pump  
Manual



Warranty  
Card

**TRANSPORT**

**CAUTION**

1. The MK-377EXP weighs approximately twenty-seven (27) pounds; use care when transporting.
2. Never transport the MK-377EXP with water in the Water Pan.

The MK-377EXP is designed with a rigid frame and removable Cutting Head making the saw easily transportable. To lift the saw, grasp the front and back of the frame at the lift points shown below.

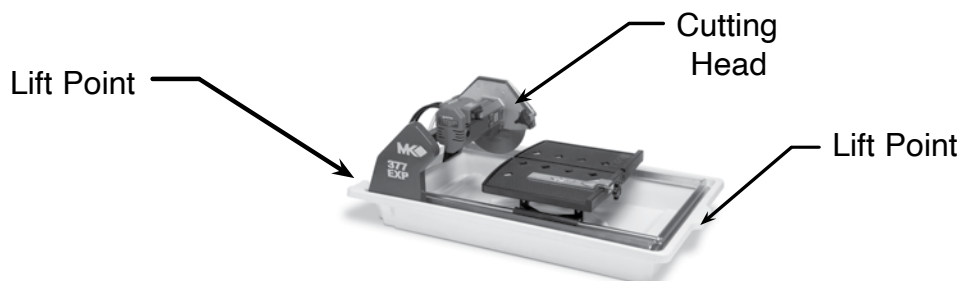

Follow the assembly instructions to prepare your MK-377EXP for operation.

**CUTTING HEAD INSTALLATION**

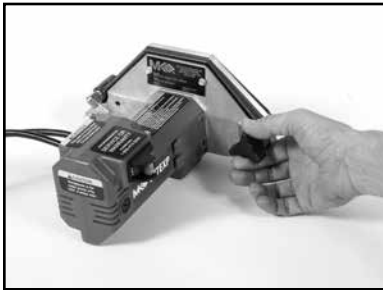

(A)  
Loosen the Blade Guard Retaining Knob.



(B)  
Remove the Blade Guard Wingnut and then remove the Blade Guard.



(C)  
Locate and remove the three Cutting Head Retaining Screws using a Phillips Screwdriver.

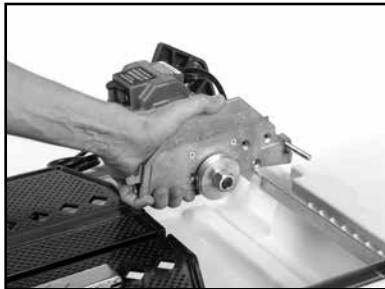

(D)  
Align the Cutting Head Retaining Holes to the holes on the Post.

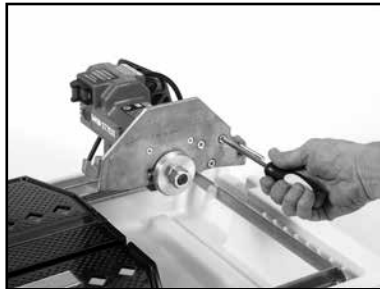

(E)  
Install the three Cutting Head Retaining Screws using a Phillips Screwdriver.

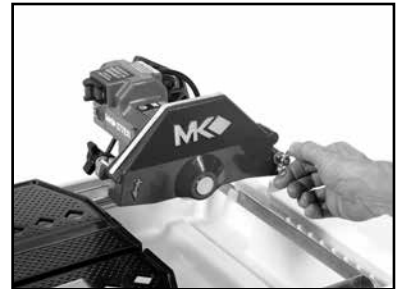

(F)  
Install the Blade Guard and tighten Wingnut and Retaining Knob.

**DIAMOND BLADE INSTALLATION**

**NOTE:** When installing the Retaining Screw, do not "cross-thread" and DO NOT over tighten the screw.



(A)  
Loosen the Blade Guard Retaining Wingnut.



(B)  
Loosen the Blade Guard Retaining Knob and open the Blade Guard.



(C)  
Place the Shaft Wrench on the Motor Shaft rotate blade shaft so shaft wrench is engaged.





(D)

Place the Blade Wrench on the Blade Retaining Nut and remove the Blade Retaining Nut and Outer Flange.



(E)

Install Diamond Blade onto Blade Shaft.

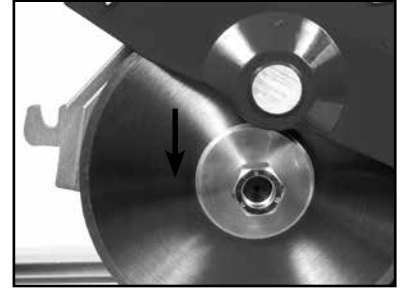

(F)

Verify the Directional Arrow of the Blade faces outward and matches the Directional Arrow of the Blade Guard.



(G)

Install the Outer Flange and Retaining Nut; install the Shaft Wrench and Blade Wrench as shown in Step D and tighten the Retaining Nut.



(H)

Close the Blade Guard and tighten the Blade Guard Retaining Knob.

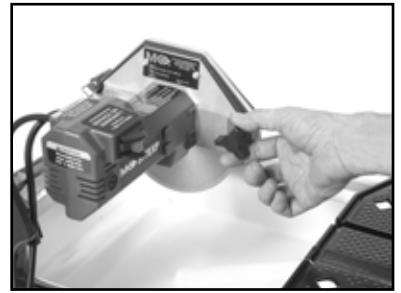

(I)

Tighten the Blade Guard Retaining Wingnut.

### CAUTION

Diamond Blades improperly used are dangerous. Comply with American National Standards Institute Safety Code, B7.1 and, Occupational Safety and Health Act covering Speed, Safety Guards, Flanges, Mounting Procedures, General Operating Rules, Handling, Storage and General Machine Conditions.

**ADJUSTABLE CUTTING GUIDE INSTALLATION**

**NOTE:** The Adjustable Cutting Guide can be used on either side of the Diamond Blade.



(A)

Loosen Adjustable Cutting Guide retaining thumbscrew and place it over the Movable Cutting Table and Ruler/Stop.



(B)

Place the Adjustable Cutting Guide onto the Movable Cutting Table and tighten the retaining thumbscrew.

**SPLASH GUARD INSTALLATION**



(A)

Remove Thumbscrew and washer from back of Blade Guard.



(B)

Install the Thumbscrew through the Washer and Splashguard then align to the hole found on back of the Blade Guard and tighten.

**PRE-START INSPECTION**

Prior to beginning work, a pre-start inspection of the saw should be performed.



(A)

Ensure the ON/OFF Switch is in the OFF position.



(B)

Inspect the Pump Assembly for damage - ensure the cord is free of cracks or cuts.

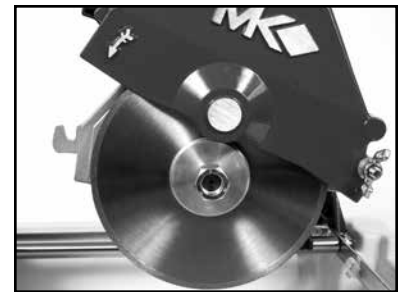

(C)

Inspect the Diamond Blade for damage – verify the blade is correct for the type of material being cut.



(D)

Inspect the MK-377EXP for damage – ensure the cord is free of cracks or cuts.

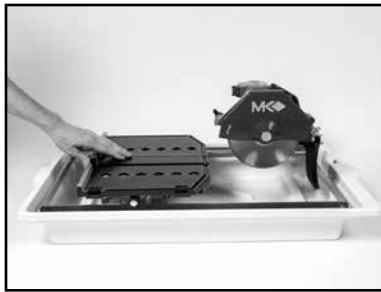

(E)

Verify the Movable Cutting Table moves freely.

**WATER PUMP PREPARATION**



(A)

Press the end of the Cooling Transfer Tube onto the Water Pump.



(B)

Connect the Cooling Transfer Tube to the inlet connection of the Blade Guard.



(C)

Place the Water Pump in the Water Pan with the suction down and insert the Pump Cord to the clip in the back. Ensure pump is against back of water pan.



(D)

Fill the Water Pan with clean water covering Pump suction (this should be done periodically during cutting).



(E)

Connect the Water Pump power cord to the connection found on the back of the motor.

**SETUP FOR OPERATION****CAUTION**

1. Before connecting the MK-377EXP to a power supply, be sure the voltage, cycle and phase meet the requirements of table below.
2. If using an extension cord, make sure the length and wire gauge correspond to the requirements listed in the table on page 10. An extension cord that is too small in wire gauge (diameter), or too long in length, will cause the motor to overheat and could cause premature failure.
3. Before connecting the MK-377EXP to a power supply, be sure the voltage, cycle and phase of the job site power source meet the requirements in the table below.
4. Use an approved Ground Fault Circuit Interrupter (GFCI).
5. Do not cover the motor vents as this could lead to motor overheating.

VOLTAGE	120v
CYCLE	60Hz
PHASE	1-phase

**NOTE:** In order to avoid breaker tripping, a 20 amp circuit breaker should be used.



(A)

Plug MK-377EXP into the GFCI (A GFCI should always be used when operating the MK-377EXP).



(B)

Plug the GFCI into the power source.

**ADJUSTMENT & OPERATION**

**⚠ CAUTION** DO NOT FORCE THE TOOL. It will do the job better and safer at the rate for which it was designed.

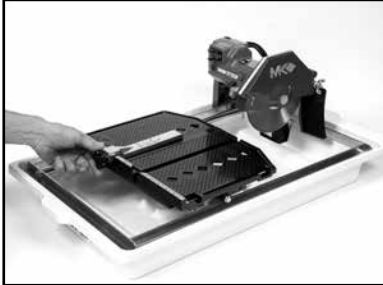

(A)

Loosen the retaining thumbscrew and place the Adjustable Cutting Guide to the desired cut length and tighten thumbscrew.



(B)

Place the tile against the Ruler/Stop and Cutting Guide.



(C)

Turn the motor ON and verify proper cooling flow on both sides of the blade.



(D)

Perform the cut. Turn the motor OFF when work is complete.

**CLEANUP**

**CAUTION** Ensure the saw is disconnected before starting the cleanup process.

**NOTE:** Dispose of wastewater in accordance with applicable Federal, State and Local laws.



(A)  
Ensure the ON/OFF Switch is in the OFF position. Remove the Cutting Assembly from the Water Pan.



(B)  
Dispose of the contents of the Water Pan and clean the pan. Replace the Cutting Assembly.



(C)  
Clean the Water Pump of all debris. (Refer to water pump manual for more detail).



(D)  
Fill the Water Pan with clean water.

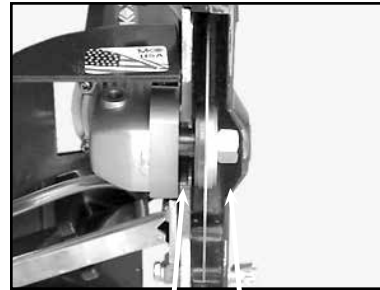

(E)  
Run the MK-377EXP until clear water is seen at the blade cooling ports (Approx. 1 minute).



(F)  
Dispose of the contents of the Water Pan and clean the MK-377EXP with soap and clear water.



(G)  
Clean the Guide Bar.



(H)  
Clean the Roller Wheel Guide Rail.



(I)  
Clean the Roller Wheels.

**CAUTION**

To extend the life of the MK-377EXP, the following procedure should be performed after each use. Lubricate all points listed below with light oils such as, MK Linear Guide Bar Lubricant, 3-IN-ONE oil, or other multipurpose spray lubricant.

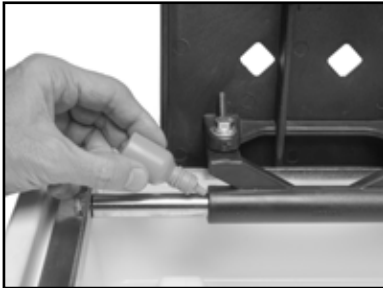

(J)  
Lubricate the Guide Bar.

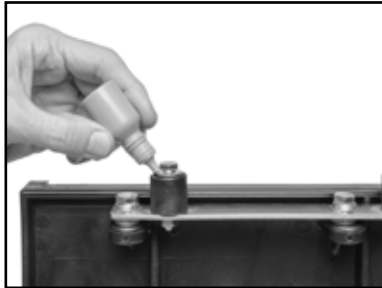

(K)  
Lubricate the Roller Assembly.

**LOCKOUT**

The MK-377EXP is equipped with a lockout device that can be used during maintenance and troubleshooting to render the saw inoperable. The lockout can also be used to prevent unauthorized use.



(A)  
Locate the Lockout Pin in the center of the ON/OFF Switch toggle (the Lockout Pin has "Remove To Lock" highlighted).



(B)  
Lockout the Saw by removing the Lockout Pin.

**MAINTENANCE**

**Monthly Maintenance**

The following maintenance should be performed monthly.

**NOTICE**

To extend the life of the MK-377EXP, lubricate the Motor Shaft with light oils such as, MK Linear Guide Bar Lubricant, 3-IN-ONE oil, or other multipurpose spray lubricant.



(A)  
Remove and clean the Inner and Outer Flanges and the Blade Retaining Nut.



(B)  
Clean the Motor Shaft.



(C)  
Lubricate the Motor Shaft.

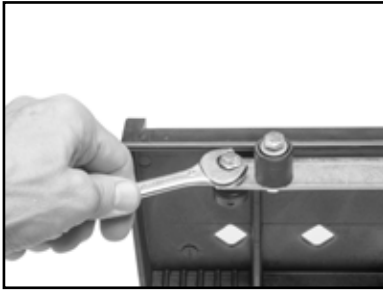

(D)

Verify the Movable Cutting Table Roller Wheel Assembly is tight.

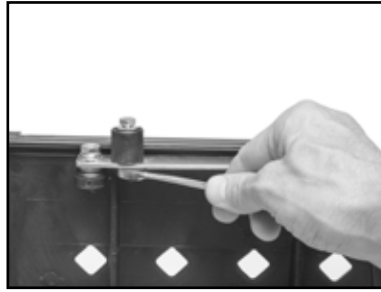

(E)

Verify the Roller Wheels are tight.

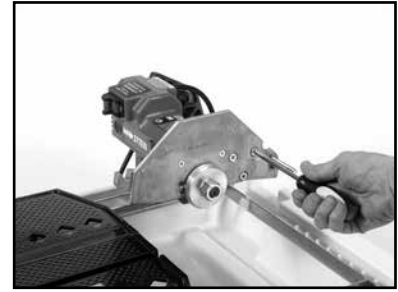

(F)

Verify the Cutting Head Assembly Retaining Screws are tight.

**BLADE DRESSING**

Like most cutting instruments, a diamond blade performs best when it is dressed. Over time and use, diamonds on the outer edge of the blade will become smoothed or "glazed" over. This will reduce grinding efficiency and may cause the blade to "wander" or bend giving the illusion of an alignment problem. When this occurs, the blade will need to be dressed. The diamond blade can be dressed using the MK Dressing Stick (part# 152972) and by following the steps below.



(A)

Setup the MK-377EXP for operation (See Setup, Adjustment and Operation).



(B)

Set the Adjustable Cutting Guide to cut a 1/16-strip.

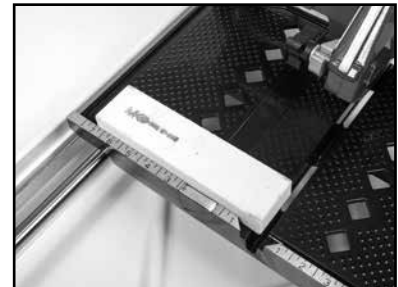

(C)

Position the Dressing Stick against the Adjustable Cutting Guide and the Ruler/Stop.

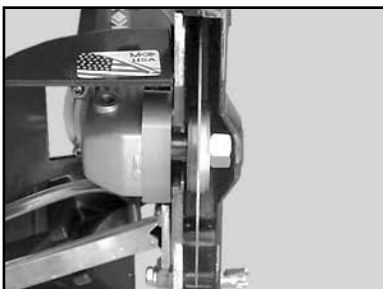

(D)

Turn the motor ON. Verify proper cooling flow on both sides of the blade.

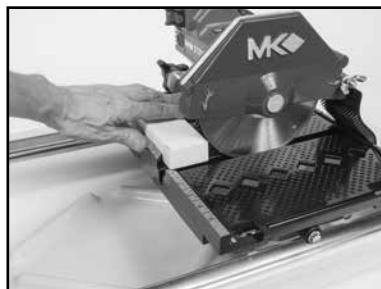

(E)

Push the Dressing Stick into the Blade in a smooth even motion to perform a cut, repeat 7 or 8 times to dress the Blade.



**MOTOR BRUSH CHANGE-OUT****WARNING**

Disconnect the tool before servicing and when changing accessories, such as blades and bits. Replacement Brush Set Part # 151774.



(A)

Locate and loosen one Motor Brush Housing Cover using a flat head screwdriver.



(B)

Remove the Motor Brush Housing Cover.



(C)

Remove the old Motor Brush.



(D)

Clean the Motor Brush Housing using a Q-tip.



(E)

Align and install the new Motor Brush.



(F)

Install Motor Brush Cap and tighten using a flat head screwdriver.



(G)

Install the second Motor Brush (Repeat Steps C to F).

**TROUBLESHOOTING**

Blade will not cut properly.



(A)

Check for Smoothness or "Glazing" (Dress blade if needed).

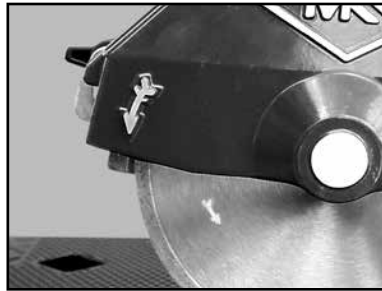

(B)

Check for proper rotation.



(C)

Ensure the Blade Core is not bent and Arbor is not out of round.



(D)

Verify the blade is correct for the material being used.

**COOLING FLOW**



(A)

Check that the Cooling Flow Adjusting Valve is FULL open.



(B)

Remove the Cooling Transfer Tube from the Blade Guard inlet and clean.

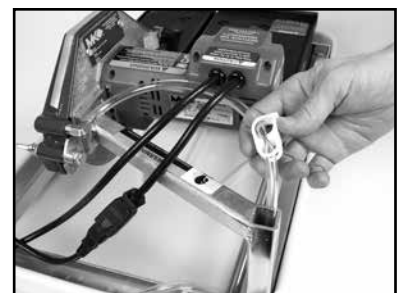

(C)

Check the cooling flow Adjusting Clamp is open.

**NOTE:** "Rodding" cooling channels is performed by inserting a small wire rod through the cooling inlet on top of the Blade Guard and directing the rod out through each of the cooling flow tubes located on the underside of the Blade Guard. The cooling channels should be "rodded" until all ports are free of foreign debris.



(D)  
Remove the Blade Guard Intake Fitting.



(E)  
Clean the Blade Guard Intake Fitting.



(F)  
Locate the Blade Guard Cooling Channels.



(G)  
Rod Cooling Channels and recheck flow.

## **MOVABLE CUTTING TABLE DOES NOT MOVE CORRECTLY**

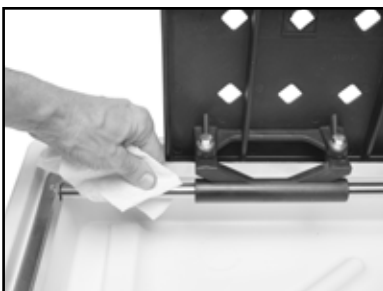

(A)  
Check the Guide Bar and Roller Wheel Guide Frame is clean - clean if dirty.



(B)  
Check the Movable Cutting Table Roller Wheels for wear replace if necessary.

**BLADE STOPS TURNING**



(A)

Check the ON/OFF Switch is in the ON position.

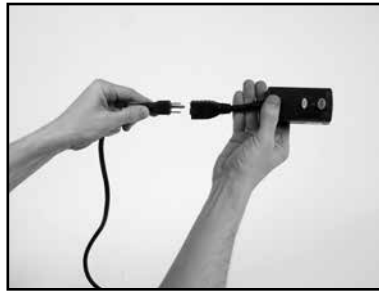

(B)

Verify all plugs are fully connected.



(C)

Check to see if the Ground Fault Circuit Interrupter (GFCI) tripped.

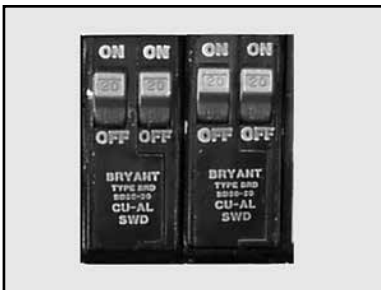

(D)

Verify the circuit breaker is at least 20 amps - if not, move to 20-amp circuit.

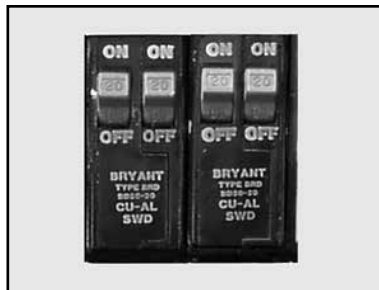

(E)

Verify circuit breaker not tripped; if it is tripped, reset it once only.



(F)

Check power source voltage is 120v - if not 120v, move to another circuit.



MK-377EXP SAW P/N 160028

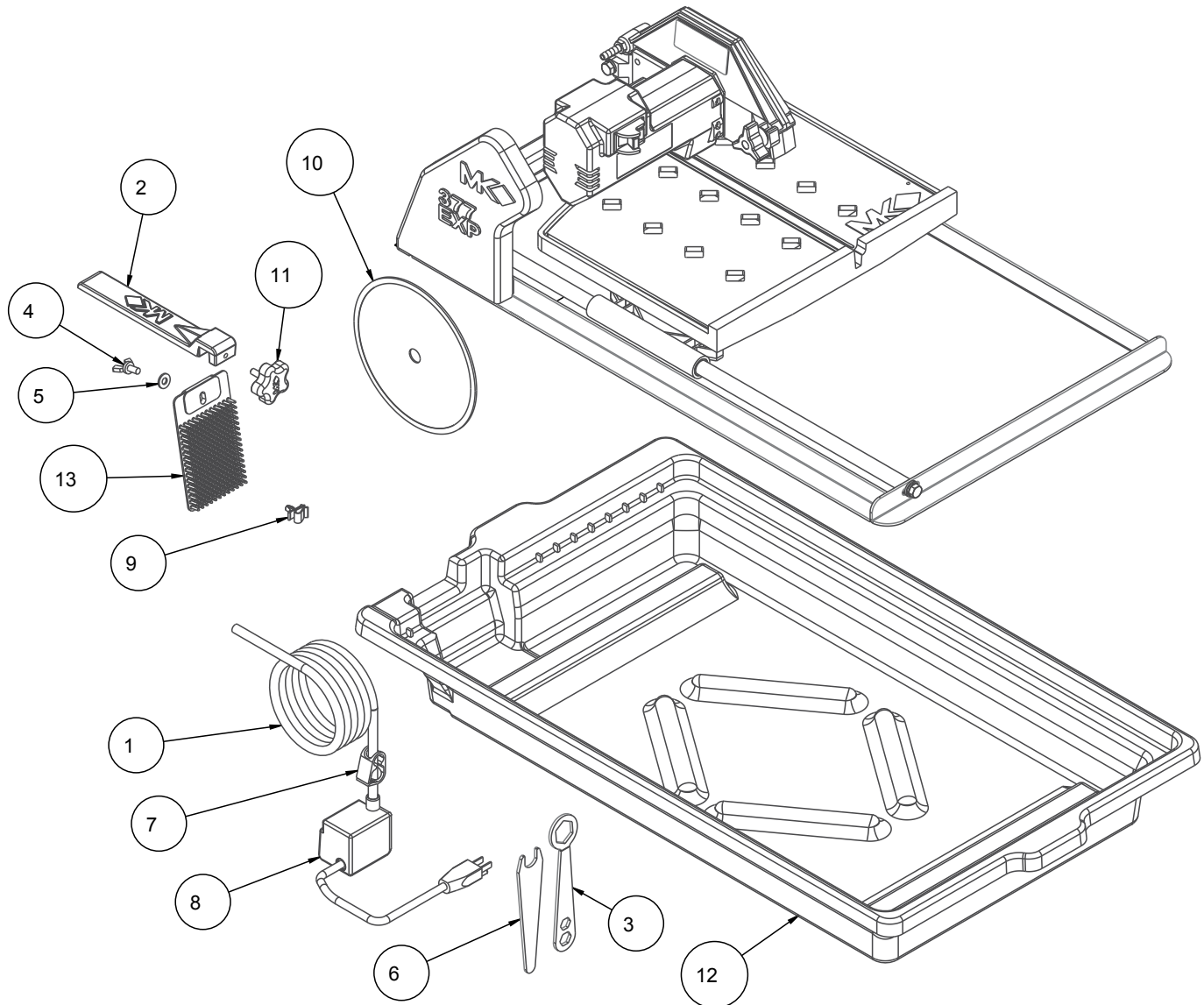

## MK-377EXP SAW P/N 160028

Item	Description	Part #	Qty
1	HOSE, VINYL, 1/4X3/8 (6.0')	132951	1
2	CASTING, ACC RIP GUIDE-COMP	134551	1
3	WRENCH, TILE SAW NUT 15/16	134684	1
4	SCREW, WING, 1/4-20X1/2	151888	1
5	WASHER, FLAT, SAE, 1/4	151915	1
6	WRENCH, TILES AW, 11/16 OPEN END	153450	1
7	CLAMP, HOSE, 1/4-1/2 FLOW	154394	1
8	PUMP, WATER, 115V 60HZ	155987-VP	1
9	CLIP, CORD 1/4" PUSH MOUNT	157259	1
10	MK-HDTCM WET 7X060X7/8	157913	1
11	KNOB, RUBBER, 1/4-20 X 3/4" LONG	159428-1	1
12	PAN, WATER MK-370EXP/1080	160041	1
13	GUARD, SPLASH	160310	1

MK-377EXP SAW P/N 160028

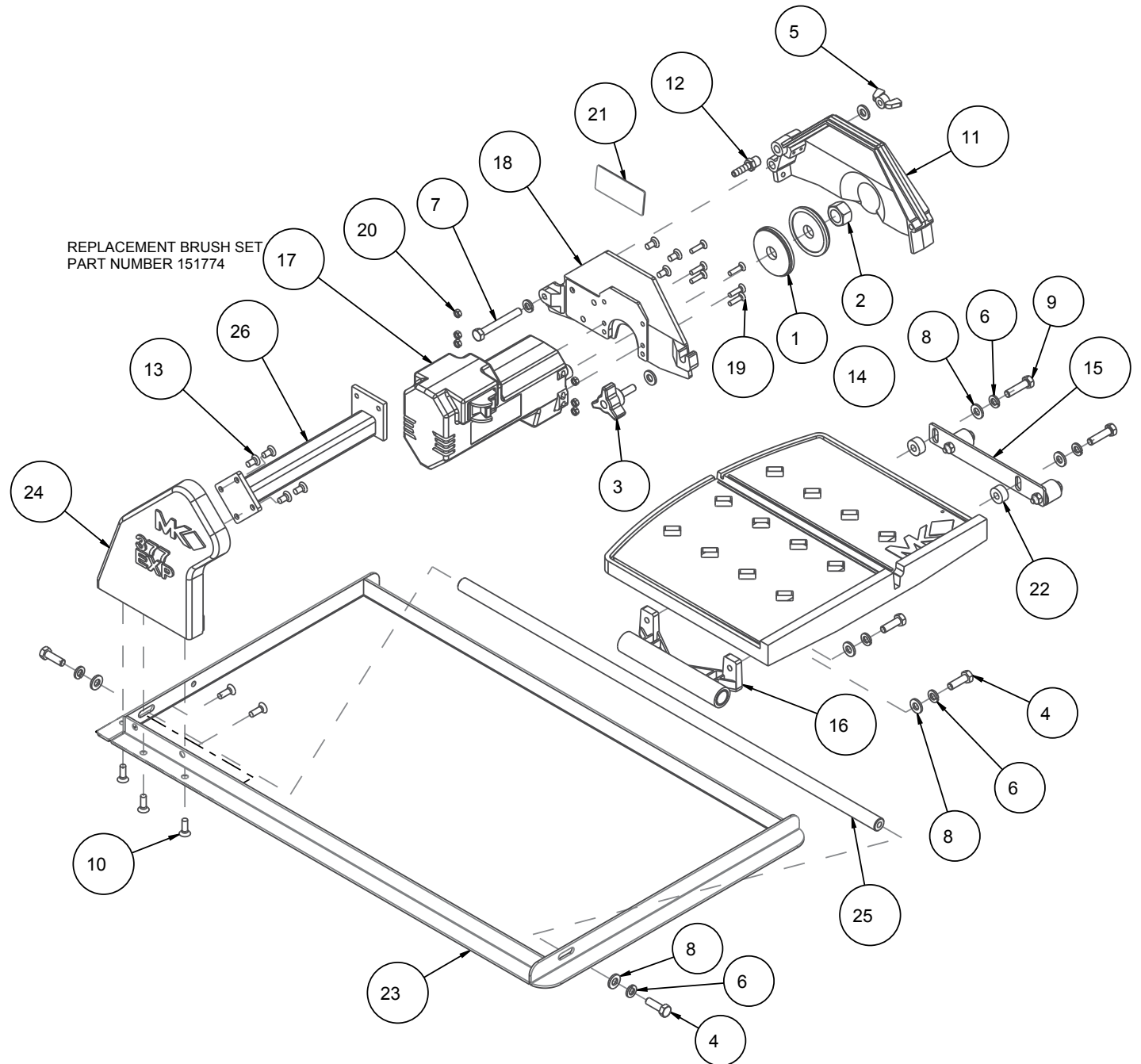



## MK-377EXP SAW P/N 160028

Item	Description	Part #	Qty
1	FLANGE, OUTER, 2-3/8	135830	2
2	NUT, HEX, 5/8-18	135848	1
3	KNOB, DAVIES, 5/16-18 X 1	151681	1
4	SCREW, HEX HD, 5/16-18 X 1	151743	4
5	NUT, WING, NYLK, 5/16-18	151746	1
6	WASHER, LOCK, SPLIT, 5/16	151747	7
7	SCREW, HEX HD, TAP, 5/16-18X2-1/2	151748	1
8	WASHER, FLAT, SAE, 5/16	151754	8
9	SCREW, HEX HD, 5/16-18 X 1-1/4	153950	2
10	SCREW, FLAT HD, 1/4-20X3/4	154657	5
11	CASTING, BLD GRD, 7", COMP	154811	1
12	FITTING, 1/8 MNPT X 1/4 BARB	155809	1
13	SCREW, FLAT HEAD, 1/4-20 X 1/2 PHIL	155812	7
14	TABLE, COMPOSITE, 377EXP	156536	1
15	ASSEMBLY, ROLLER WHEEL	156586	1
16	BEARING, LINEAR, 5/8 X 6, NYLON	157126	1
17	MTR, 5.0 AMP 115V 50/60HZ	157226-G	1
18	CASTING, 170, MOTOR MOUNT, COMP	157403	1
19	SCREW, FLAT HD, M5-.8X16MM	157404	6
20	NUT, HEX, M5-.8	157405	6
21	TAG, SERIAL NUMBER, BLANK	157500-RW	1
22	SPACER, 5/16 X 3/4 X3/8	166782	2
23	WELDMENT, FRAME	167449	1
24	CASTING, POST, COMP	172785	1
25	BAR, GUIDEØ 5/8 X 26.44L	172786	1
26	ARM, CUTTING HEAD, 377EXP	172787	1

ITEM	NUMBER	DESCRIPTION	
1.	139295	MK-200, 7" x 5/8 Arbor Premium grade Diamond Blade for smooth, chip-free cutting on tile	
2.	139311	MK-215, 7" x 5/8 Arbor Supreme grade diamond blade for hard materials	
3.	153293	MK-315, 7" x 5/8 Arbor Supreme super hi-rim diamond blade	
4.	134577-MK	Dual 45° Flat Angle Guide	
5.	134551-MK	Rip Guide	
5.	134569-MK	90° Protractor	
6.	152792	Dressing Stone	
7.	152610	Ground Fault Circuit Interrupter	
8.	160131	Stand for 7" Tile Saw	



**ORDERING INFORMATION**

---

You may order MK Diamond products through your local MK Diamond distributor or, you may order direct from MK Diamond.

When ordering direct from MK Diamond, please have the following information ready before calling:

- The Model Number of the saw
- The Serial Number of the saw
- Where the saw was purchased and when
- The Part Number for the part(s) being ordered
- The Part Description for the part(s) being ordered

**NOTE:** There is a \$25.00 minimum order when ordering direct from MK Diamond. A \$6.00 charge will be added to orders having a net billing value under \$50.00. All purchases must be made using VISA, MasterCard or American Express.

All parts may be ordered by calling toll free to – 800 421-5830 or 310 539-5221 and asking for Customer Service. For technical questions, call – 800 474-5594.

**RETURN MATERIALS POLICY**

---

To expedite the service relative to the return of a product purchased through MK Diamond, please observe the following:

**NOTE:** When returning all items, they must have been purchased within the previous twelve (12) months.

- Have the Model Number of the saw
- Have the Serial Number of the saw
- Have the location of where the saw was purchased
- Have the date when the saw was purchased
- Contact Customer Service for approval to return the item(s)
- Obtain a Returned Goods Number (RGA) authorizing the return
- Follow the packaging instructions in the following section
- Ensure the RGA number is on the outside of the returned package
- Ensure your item(s) are prepaid to the destination

For returned items, call toll free to – 800 421-5830 or 310 539-5221 and ask for Customer Service.

**PACKAGING INSTRUCTIONS**

---

- Remove the Cutting Head and Support Angle Assembly
- Dry the saw before shipping
- When packing, include the following: Saw, Diamond Blade, Blade Guard and Support Angle Assembly and Adjustable Cutting Guide (Other Accessories are not required)
- Package the unit in its original container or one of comparable size (do not ship the unit partially exposed)
- Ensure all parts are secured in the packaging to prevent moving

**AUTHORIZED SERVICE CENTERS**

---

For quicker repair time, you may contact MK Diamond Customer Service, toll free, at 800 421-5830 or 310 539-5221 for the Authorized Service Center closest to you or visit our web site at [www.mkdiamond.com](http://www.mkdiamond.com). For technical questions, call – 800 474-5594.

**CONTACT**

---

Please contact MK Diamond Products, Inc. Customer Service Department with any questions you might have regarding distributors, parts or service.

Telephone: **(800) 421-5830**

Fax: **(310) 539-5158**

E-mail: **Customer\_Service@MKDiamond.com**

Customer Service Hours: **Monday through Friday, 6AM-4PM PST**

**MK Diamond Products, Inc.**

**1315 Storm Parkway**

**Torrance, CA 90501**

**MK DIAMOND PRODUCTS, INC. LIMITED WARRANTY**

---

MK DIAMOND PRODUCTS, INC. will guarantee every machine they build, to be free from defects in material and workmanship for (1) one year from date of purchase. The obligation of MK DIAMOND PRODUCTS, INC. under this warranty is limited to the repair or replacement of any parts which, under normal use, prove to be defective in material or workmanship. The parts involved or the unit in question should be returned to MK DIAMOND PRODUCTS, INC. or to a point designated by us, transportation prepaid.

This warranty does not obligate us to bear the cost of labor or transportation charges in connection with replacement or repair of defective parts. Likewise, it shall NOT apply to any unit which has been subjected to misuse, neglect or accident. This warranty does NOT apply to any machine which has been repaired or altered outside our factory.

This warranty does NOT obligate MK DIAMOND PRODUCTS, INC., with respect to items not of our manufacture, such as engines, motors, hydraulics, etc., which are subject to their own guarantees and warranties.

We shall in no event be liable for consequential damages or contingent liabilities arising out of failure of any equipment or parts to operate properly.

**WARRANTY:** For your (1) one year warranty to be effective, complete the online Product Registration as soon as possible. Visit **[www.mkdiamond.com/registration](http://www.mkdiamond.com/registration)**

**© COPYRIGHT 2019, MK DIAMOND PRODUCTS, INC. ALL RIGHTS RESERVED.**

The MK Diamond logo is a registered trademark of MK Diamond Products, Inc. and may not be used, reproduced, or altered without written permission. All other trademarks are the property of their respective owners and used with permission.

MK Diamond may have patents, patent applications, trade marks, copyrights of other intellectual property right covering this product in this document.

This manual **MUST** accompany the equipment at all times. This manual is considered a permanent part of the equipment and should remain with the unit if resold.

The information and specifications included in this publication were in effect at the time of approval for printing.





**MK-377EXP TILE SAW**  
**OWNER'S MANUAL & OPERATING INSTRUCTIONS**



**MK Diamond Products, Inc.**

MK Diamond Products, Inc.  
1315 Storm Parkway  
Torrance, CA 90501

Toll-Free: (800) 421-5830  
Phone: (310) 539-5221  
Fax: (310) 539-5158  
[www.mkdiamond.com](http://www.mkdiamond.com)