

Features

- 31.25" x 18" x 9"
- 18 gauge, 304 stainless steel
- Undermount sink
- Handcrafted
- Easy-to-clean, brushed finish
- Spray insulated undercoating & sound pads
- Includes template & installation hardware
- Limited lifetime warranty



OPTIONAL ACCESSORY:

BG 333 Bottom Grids

CODES:

ASME A112.19.3/CSA B45.4, cUPC

Product Diagram

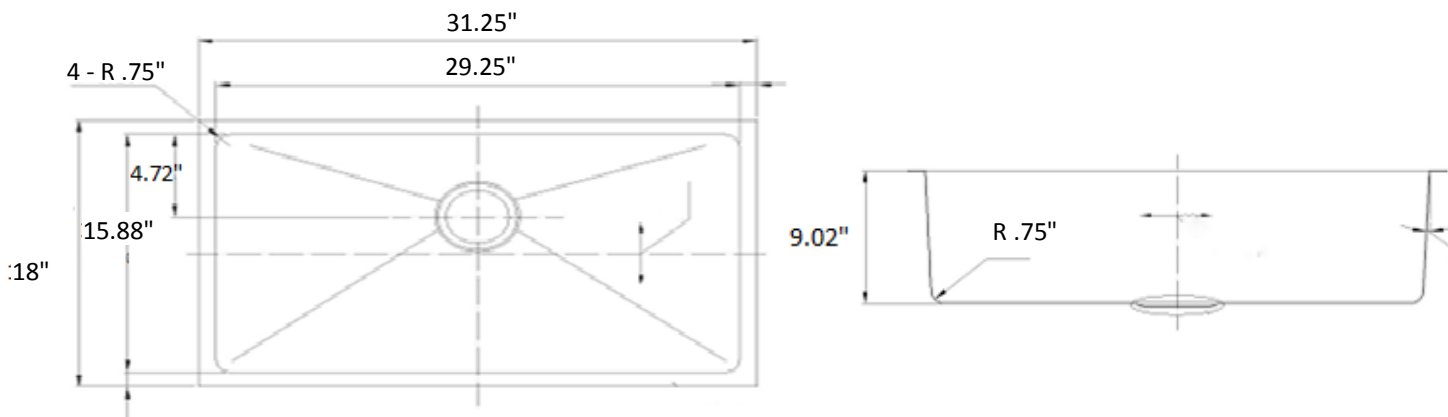

1-877-500-SINK (7465)

WEST COAST WAREHOUSE: 510-667-9998  EAST COAST WAREHOUSE: 404-691-5088

WWW.AMERISINK.COM