



VINYL SHOWER PAN LINER

In 1965 **PASCO** was the first company to introduce a plastic shower pan liner for ceramic tile showers. Since that time, over 40,000,000 square feet of our shower pan liner has protected hundreds of thousands of ceramic tile showers.

We led our industry in developing a nationally recognized product standard for shower pan liner. Furthermore, we led the way in developing and implementing the installation standards for the plumbing code bodies throughout the United States.

PASCO Vinyl Shower Pan Liner has served and continues to serve the plumbing trade like no other product.



40 Mil Red Shower Pan Liner



Available in Red & Gray
IAPMO Listed

PART NUMBER	WIDTH	LENGTH
3045	48"	80 Ft.
3047	60"	
3049	72"	

PART NUMBER	WIDTH	LENGTH
3045-40	48"	40 Ft.
3047-40	60"	
3049-40	72"	

30 Mil Black Shower Pan Liner



IAPMO Listed

PART NUMBER	WIDTH	LENGTH
3018	60"	80 Ft.
3020	72"	

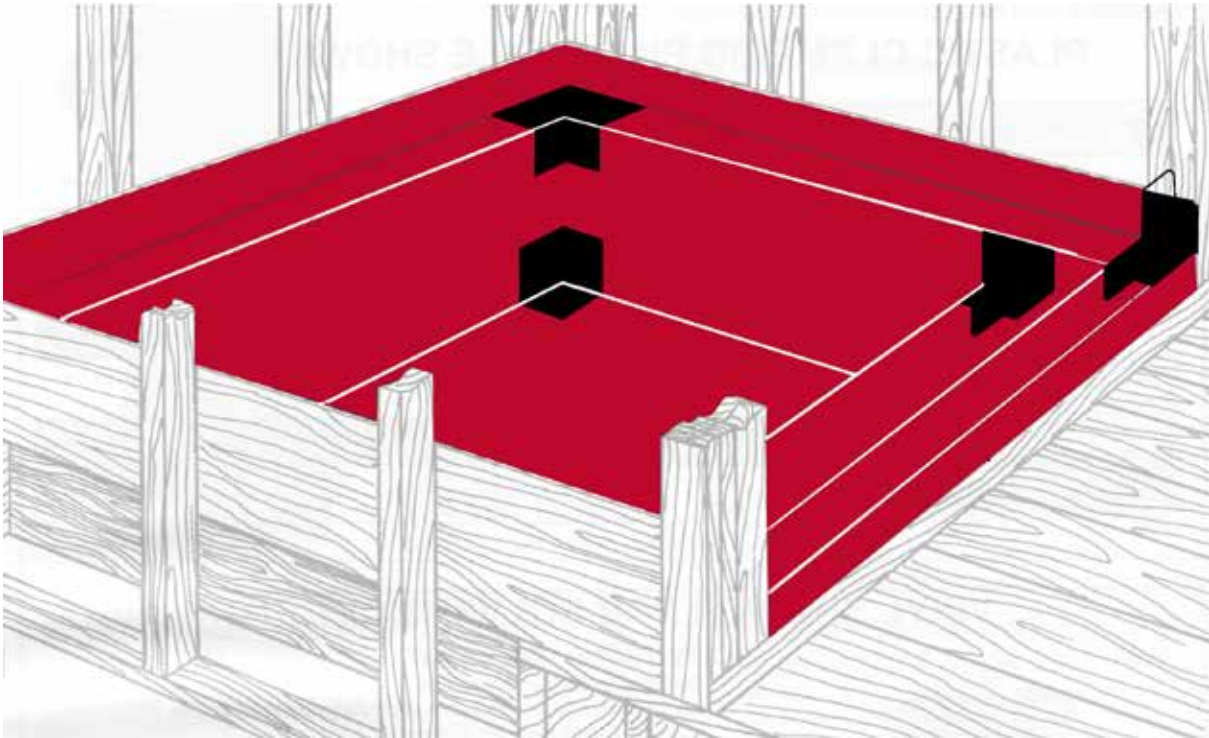

This type of installation will probably never exist. It is to illustrate all the corner applications.

PRE-FAB CORNERS

3000

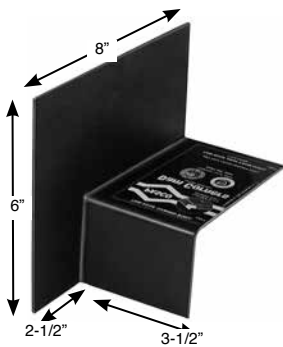

Flush Dam Corner
Use where a flat wall or stall backing board meets a dam at a 90° angle.

3002

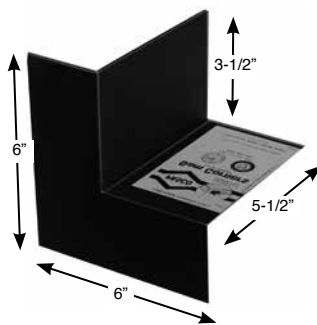

Return Dam Corner
Use where wrap-around protection is necessary.

3003

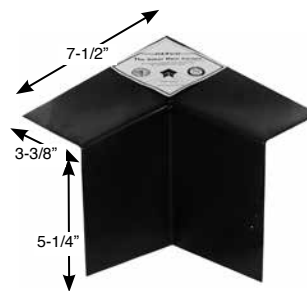

Top Dam Corner
Use where a wide 90° top corner of a two dam stall or roman tub meet.

3005

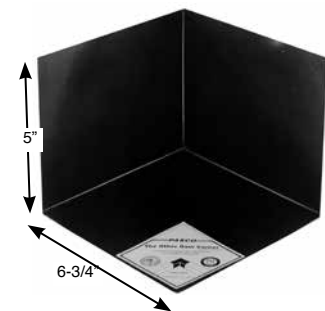

Inside Corner
For deep tubs. Prevents folded pan buildup in corners.



Vinyl Shower Pan Cement



PART NUMBER
3008

Pint size only

DIRECTIONS FOR USAGE:

1. Surfaces to be joined must be clean and dry.
 2. Apply cement with dauber or short natural bristle brush. If cement appears jellied, it may be thinned by adding a small amount of acetone.
 3. To join sheets allow a 4" minimum overlap. Apply a thin even coat of cement to both surfaces to be joined. The entire surface of material to be joined must be covered with cement. Apply the cement to short lengths of material, not to exceed 3' at a time.
 4. Join cemented surfaces as quickly as possible before cement dries. For seams exceeding 6' in length, use a weighted, smooth flooring roller to facilitate bonding material.
 5. Apply a wide bead of cement to the entire length of the overlap. If material has been joined outside of installation area, apply the bead to both top and bottom edges of the overlap.
 6. Do not disturb or try to peel joined surfaces. The cemented seam should fully cure in 24 hours.
- NOTE: COMMON PVC PIPE CEMENT WILL NOT SOLVENT WELD VINYL SHOWER PAN LINER

Shower Pan Caulk

Excellent for sealing between shower pan liner and shower drains

Can be used anywhere an economical, weather resistant, long life sealant is required

PART NUMBER	SIZE
1709	10 oz Cartridge



Plastic Shower Drain

Clamping Ring Style for Ceramic Tile Showers
• Add suffix BN for Brush Nickel



4" diameter strainer
2" IPS plastic tailpiece allows adjustments to desired level
Fits over 2" or inside 3" Schedule 40 DWV

PART NUMBER	MATERIAL	DRAIN CONNECTION	TOP FLANGE DIAMETER	BOTTOM FLANGE DIAMETER
8015	PVC	2"-3" PVC	5-1/4"	6-1/2"
8016	ABS	2"-3" ABS		
8019	4" STAINLESS STEEL STRAINER			



2" Quick Connect Shower Drain



Protected with TechCoat finish

Quick Clamping Gasket And Collar For Ceramic Tile Showers

Clamping collar securely attaches drain to drain line

Speeds installation

Extra heavy (.050) strainer

PART NUMBER	TOP FLANGE DIAMETER	BOTTOM FLANGE DIAMETER
7990	5-1/2"	7"

"Quick Test" Shower Drain



For Ceramic Tile Showers
Threaded for test nipple
Extra heavy (.050) strainer

Protected with TechCoat finish

PART NUMBER	DRAIN CONNECTION
8006	2" IPS
8007	1-1/2" IPS
8008	2" CAULK
8011	2" CAULK w/Gasket
8012	2" NO-HUB

PART NUMBER	DESCRIPTION
8009	QUICK CAULK RUBBER GASKET ONLY

2" Quick Set Shower Drain

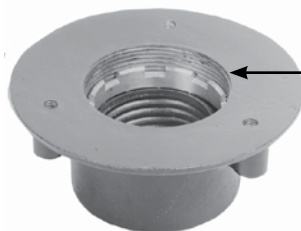

Internal locknut & gasket

Protected with TechCoat finish

For Ceramic Tile Showers
Internal locknut and gasket for 2" DWV
Extra heavy (.050) strainer

PART NUMBER	TOP FLANGE DIAMETER	BOTTOM FLANGE DIAMETER
8014	5-1/2"	5-1/2"

Shower & Floor Drain

- Add suffix BN for Brush Nickel

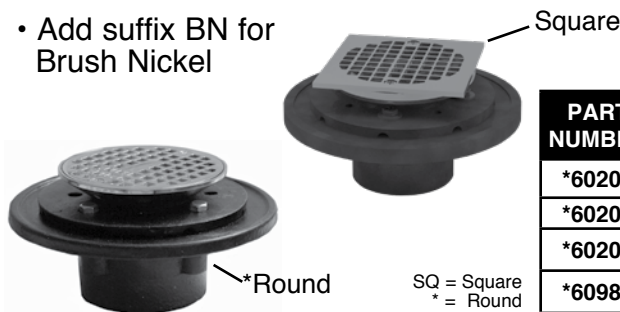

Adjustable strainer
4-3/16" Heavy chrome plated brass strainer with brass spud

SQ = Square
* = Round

PART NUMBER	PART NUMBER	DRAIN CONNECTION	TOP FLANGE DIAMETER	BOTTOM FLANGE DIAMETER
*60201	60201SQ	2" INSIDE CAULK	5"	7"
*60203	60203SQ	2" IPS		
*60205	60205SQ	2" NO-HUB		
*60981	60981SQ	4-3/16" Threaded chrome plated brass strainer only		



History

In 1965, **PASCO** Specialty & Mfg., Inc. became the pioneer in the application of vinyl shower pan liner under a full mortar bed tile installation as a waterproofing alternative to the expensive and often unreliable hot mop, copper or lead sheets and composite methods. Since that date, **PASCO Vinyl Shower Pan Liner** has waterproofed over 6,000,000 ceramic tile shower stalls, gang showers, steam rooms and roman tubs.

Product Information

PASCO Vinyl Shower Pan Liner:

1. Meets or exceeds the specifications of ASTM D4551, which specifically covers vinyl shower pan liner.
2. Is manufactured from 100% Virgin Poly Vinyl Chloride Resin.
3. Is treated with biocides which prevent the growth of mold, mildew or fungus.
4. Is unaffected by concrete or cement.
5. The product maintains its integrity when installed in a damp, moist environment (the typical shower pan) away from the effects of sunlight and ozone. Under no circumstances should **PASCO Vinyl Shower Pan Liner** be used where there is direct exposure to the elements. Contact **PASCO** with specific requirements.

2 Different Thicknesses

Due to the multitude of plumbing code bodies and plumbing inspection jurisdictions, various thicknesses have been approved. **PASCO** offers the installer a choice of two thicknesses. Please check with local plumbing inspection department to be sure which thickness is approved. Regardless of the thickness, all **PASCO Vinyl Shower Pan Liner** is manufactured to the same exacting specifications.

Pre Fab Corners

PASCO is the only company that offers 4 styles of prefabricated shower stall corners (installation standard IS 4-92 of The Uniform Plumbing Code (UPC) requires the use of shower stall corners in shower pan installations). Folding **PASCO Vinyl Shower Pan Liner** at the corner of the dam and wall can sometimes present problems. These prefabricated corners allow the installer to properly seal those areas where bare wood may be exposed to moisture damage. Although each corner is designed for a specific application, the versatility and large size allows the installer to make a waterproof seal in virtually any corner.



Markings

PASCO Vinyl Shower Pan Liner is clearly marked with **PASCO's** company name, address, ASTM D4551, appropriate listing logos, thickness and width.

Typical Applications

Shower pans, gang shower pans, steam rooms, fountains, ornamental or reflecting pools. Any application of a full mortar bed (defined as any area requiring a minimum of 1" of mortar) and ceramic tile which requires a waterproof underlayment.

Installation

PASCO Vinyl Shower Pan Liner is relatively easy to install. However, the installer must be familiar with the step by step instructions contained in this brochure.

Installation of **PASCO Vinyl Shower Pan Liner** must be made in accordance with local plumbing codes. For technical, specification or installation assistance please contact **PASCO**.

Approvals and Listings

PASCO Vinyl Shower Pan Liner was first approved by the city of Portland, Oregon in 1966. The following are specific listings or approvals:

*30 mil and *40 mil - IAPMO File 2308

*40 mil complies with section 417.5.2.1 of the International Plumbing Code (IPC)

*NOTE: A layer of standard grade fifteen (15) pound asphalt impregnated roofing felt must be formed to the sub-base prior to installing the *30 mil material. Manufacturer furnished dam corners are required.



WARNING:

PASCO's Shower Pan Liner can expose you to chemicals, including DEHP, DINP, DIDP, Antimony Trioxide and Vinyl Chloride and Shower Pan Solvent Cement can expose you to chemicals, including Benzene and Formaldehyde which is known to the State of California to cause birth defects, reproductive harm and cancer. For more information, go to www.p65warnings.ca.gov

PASCO requires that its shower pan liner be installed by professional and licensed contractors only who are totally familiar with the proper installation requirements and the requirements of the local building or plumbing code jurisdiction.

Proper hand protection, such as disposal latex or nitrile gloves, and goggles to protect your eyes must be worn when installing this product.

Code recognized installation procedures are published in the Uniform Plumbing Code and are also available along with our Safety Data Sheets on our website at www.pascospecialty.com.

Please call 800-421-2053 for additional information.



Installation Instructions

PASCO Vinyl Shower Pan Liner is installed after the carpenters have finished the rough shower stall and dam. To provide support for the shower pan material, blocking of 2" x 10"s must be placed between the lower end of the studs, forming the shower stall. The outer face of the blocking must be flush with the studs, forming the shower stall. **PASCO Vinyl Shower Pan Liner** works with a clamping flange-type drain made of either cast iron or plastic.

Figure 2: The lower flange of the drain must be braced or resting on firm material to prevent any upward or downward movement.

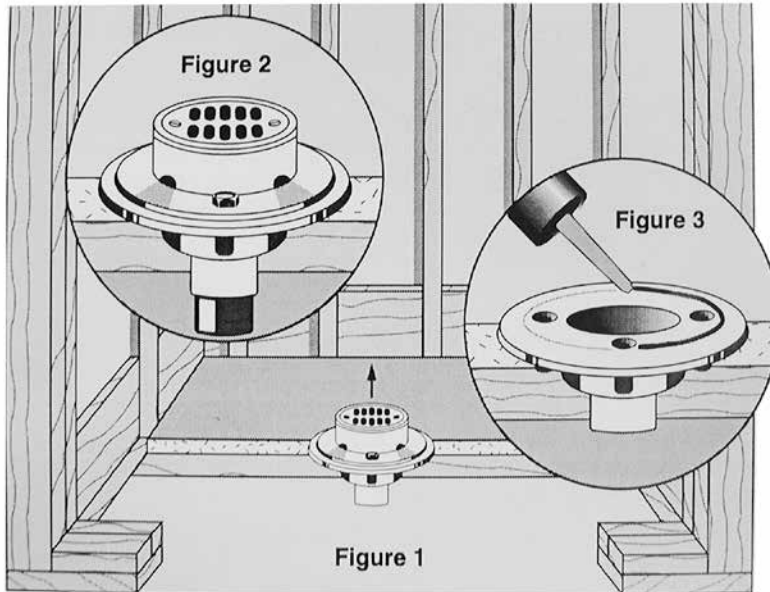

1. Sloping Shower Stall Subfloor

To prevent puddling of moisture and to provide a smooth base for the shower pan material, a shower stall subfloor must be installed with a slope toward the drain of a 1/4" fall per foot.

Figure 1: Construct the sloped subfloor using a mortar mixture of 1 part portland cement to 4 parts sand. Staple a layer of 15 lb. roofing felt to the subfloor of the shower stall. Cover the felt with the mortar mixture and trowel toward the drain. Be sure the drain is placed so that the top half edge of the drain flange is level with the top of the sloped subfloor. **Figure 2:** Allow the sloped subfloor to dry before proceeding with the installation of the shower pan liner. Be sure the sloped subfloor is dry and free of any debris such as nails, staples, etc. **PASCO Vinyl Shower Pan Liner** can be applied directly to the sloped subfloor surface.

2. Lining the Stall with the Vinyl Shower Pan Liner

Remove the top half of the shower drain. To insure a waterproof seal between the lower drain flange and the pan material, apply a small ring of **PASCO 1709** caulking on top of the lower drain flange. The ring of caulking must be on the outer perimeter of the drain bolt holes, **Figure 3**. Do not plug the bolt holes or weep holes with caulk. **IMPORTANT**-Do not use roofing mastic as a sealer around the drain. Measure the width and length of the stall area allowing 10 inches for each wall and about 16 inches for the dam. The dam must be covered by the liner on the inside face, top and outside face. After determining the amount of material needed, use a soft crayon or felt tip marker to draw a layout of the pan on the material,

Figure 4: Cut the material with a utility knife and straight edge. Fold the pan material along the layout lines and place it in the shower stall. After the material is positioned in the stall, it can be either stapled or tacked into place. Never staple lower than three inches above the level of the dam. Place the first staple in the pan material to the backing board beginning in the middle of the back of the stall. Proceed to staple the material to the backing board at 2" intervals, working towards either corner of the stall.*

***NOTE: Where metal studs are used and no back-up material is provided, see Gang Shower Installation Instructions.**

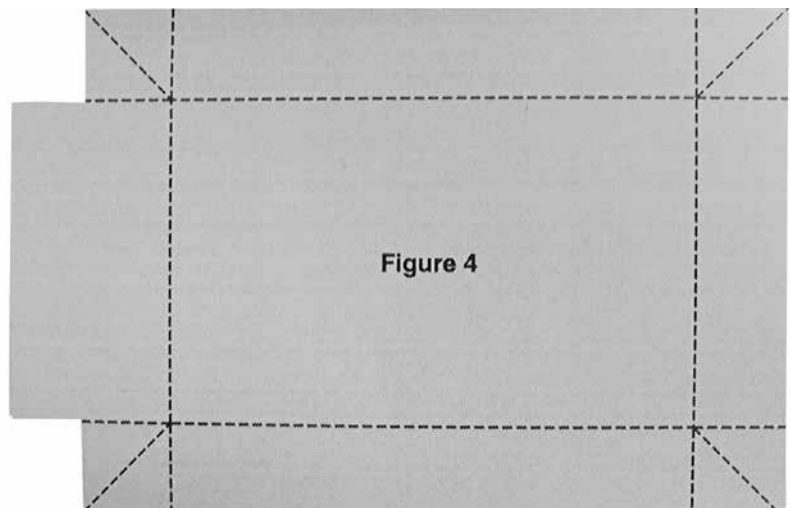

Make corner folds as indicated in **Figure 5** and staple. Continue stapling the material, working towards the shower stall front. Try to keep the material as even and free of wrinkles as possible. Fold corners at the dam and fasten securely. The folds at the dam are somewhat tricky. Try to make the fold as smooth as possible. If it becomes necessary to make a slit in the material at the dam corners, we recommend that you use **PASCO Pre-Fab Corners** to protect against leakage. After securely fastening the material on the outside of the dam (do not staple the material on top of the dam), cement the **PASCO Pre-Fab Corners** in place using **PASCO Vinyl Shower Pan Liner Solvent Cement**, **Figure 6**. The top half of the shower

drain can now be bolted into place. Cut the material covering the drain opening, **Figure 7**. Do not make the cut larger than the drain opening. Locate the bolt holes, make small slits and bolt the drain halves firmly in place. To properly tighten, some drain styles may require a gasket of extra pan material. Simply cut this gasket from a piece of scrap material and cement it into place over the drain half.

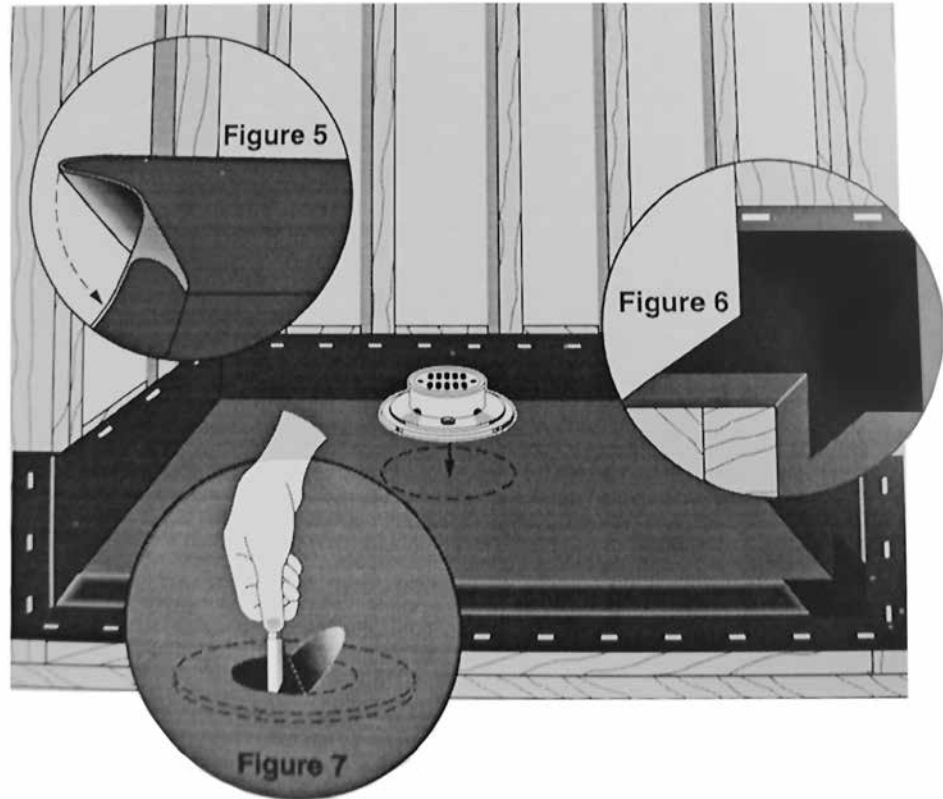

3. Test for Water Tightness

Test the shower pan for water tightness by plugging the drain with the appropriate size test plug or nipple when using **PASCO's Quick Test Shower Drains**. The

test plug or nipple must be placed in the drain below the level of the weep holes. Fill the shower stall to the top of the dam for a period of time sufficient to establish its water tightness. Local codes require certain time limits for this test. Remove the

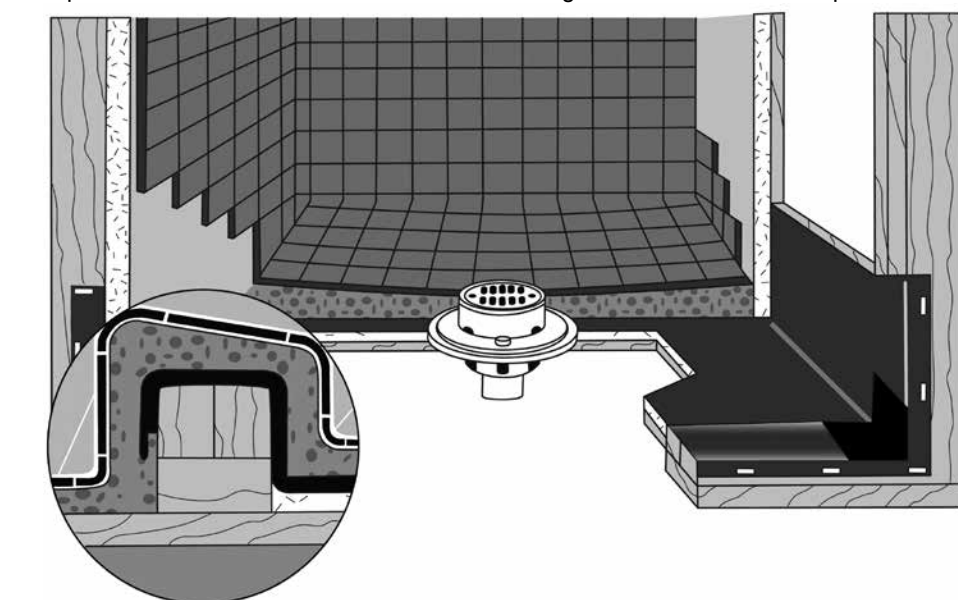

test plug or nipple and the water will drain through the weep holes of the drain. Cover the weep holes with small bits of gravel or broken tile to prevent them from becoming plugged when the mortar is poured. The shower pan installation is now complete and ready for the tile mortar base and waterproof wall material. Wrinkles in the material will flatten when the mortar is poured. If for some reason the mortar is not poured immediately after the pan has been installed, cover the pan areas with cardboard to protect it from damage. Remove the cardboard before pouring the mortar.



4. Replacing an Existing Leaking Shower Pan

An existing leaking shower pan can be replaced using the following method.

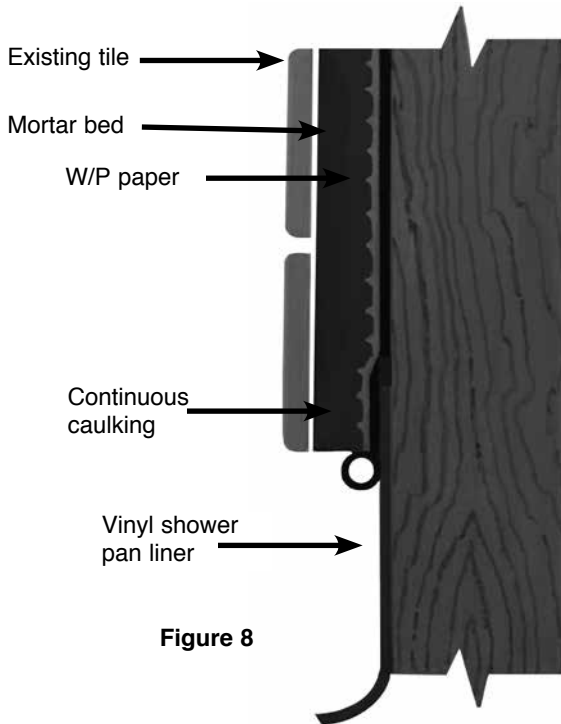

Remove the tile floor and the first course of tile from the wall of the shower stall using a small sledge hammer, crow bar or pry bar. Be sure to wear goggles.

Remove all material down to the original subfloor, including the old shower pan. If the subfloor is wooden, inspect it carefully for rotten floor boards that will need replacing. If no subfloor is evident, we recommend that one be installed as described in Section 1. Inspect the dam area for rotten boards and replace any if necessary. Install the shower pan material as described previously, but with the following modifications. Be sure that there is room for a minimum of one-half inch of mortar plus the thickness of the tile. If this amount of space is available, then the vinyl shower pan liner does not have to be recessed flush to the studs. Measure the area to be covered with liner as described before. The liner need only go up the walls far enough to meet sound tile and mortar. Tuck the liner up under existing tiles as far as possible and secure with staples or by tracking. A continuous bead of butyl rubber caulking should be applied to the area where the liner meets the existing sound tile and mortar. Test for water tightness as described previously. Metal building lath is used to back the mortar for the new tile. Measure lath and cut to fit. Be careful not to puncture the shower pan liner when placing lath. Install full mortar bed and tile to industry specifications and local plumbing or building codes, **Figure 8**.

Shower Pan Joining Instructions

Due to the variety of widths, lengths and heights of shower stalls, gang showers and similar areas which require waterproofing, it may be necessary to join widths of **PASCO Vinyl Shower Pan Liner**. The following instructions must be followed very carefully to achieve a waterproof seal.

IMPORTANT - Use only **PASCO Vinyl Shower Pan Liner Solvent Cement** (Part Number 3008) for joining pan sheets. It is specially formulated to make a permanent waterproof seal when used as directed. To join sheets allow a 4" minimum overlap. Apply a thin, even coat of cement to both surfaces to be joined. The entire surface of material to be joined must be covered with cement. Apply the cement to short lengths of material, not to exceed 3 feet at a time, **Figure 9**.

Join cemented surfaces as quickly as possible before cement dries. For long seams exceeding 6 feet in length, use a weighted, smooth flooring roller to facilitate bonding of material, **Figure 10**.

Apply a wide bead of cement to the entire length of the overlap. If material has been joined outside of the installation area, apply the bead to both top and bottom edges of the overlap, **Figure 11**.

Do not disturb or try to peel joined surfaces. The cemented seam should fully cure in 24 hours. Test for water tightness as described in section 3.

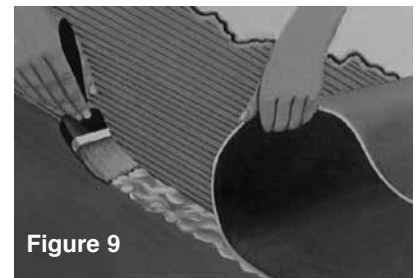

Figure 9

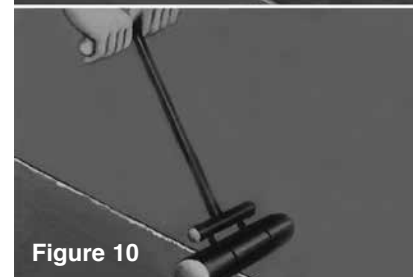

Figure 10



Figure 11

GANG SHOWER INSTALLATION

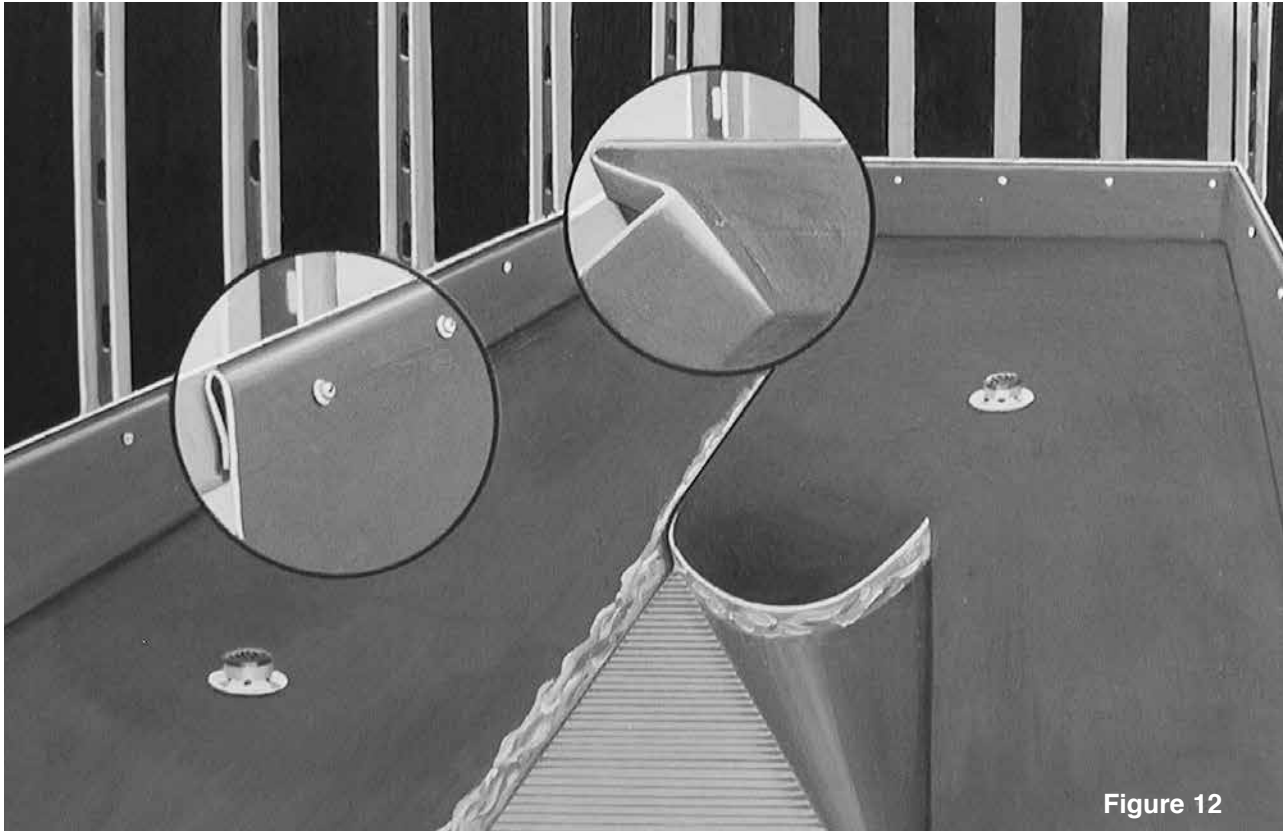

Figure 12

Shower areas with multiple shower heads and drains are commonly referred to as “gang showers”. These shower areas are found in schools, dormitories, sports facilities and commercial installations.

Read the previous instructions in this brochure and pay particular attention to the corner, drain and seaming details (see Figures 1 through 11).

When large areas must be covered, **PASCO Vinyl Shower Pan Liner** can be easily joined. Sections of the liner can be joined as they are laid. Lay sections to be joined, side by side and follow the instructions for joining as explained in Figures 9 through 11.

If metal studs are present, proceed as follows. The shower pan material must be attached at the height of at least three inches above the highest flood level of the shower area. Determine this height and attach a metal furring strip at this level around the entire shower stall area.

Measure the shower area, determine the amount of material required and also determine where seams will be required. To attach the shower pan material to the metal furring strip, fold the material as indicated in Figure 12. Use a small diameter, short length, self tapping sheet metal screw with a small washer to fasten the material to the metal furring strip. Space screws at a distance which will prevent the material from sagging.

Finish the drain installation as described in Figure 7 and perform appropriate water test as described in installation section # 3.



Product Specification Sheet

Product Name:

PASCO Vinyl Shower Pan Liner

Manufacturer:

PASCO Specialty & Mfg., Inc.

Product Usage:

PASCO Vinyl Shower Pan Liner is a flexible sheet used without bedding mastic or coating for construction of concealed water-containment barriers.

Listed by the model building code of IAPMO, **PASCO Vinyl Shower Pan Liner** may be used for safe pans, ceramic tile tub and shower stalls, indoor swimming pools, steam rooms, fountains and planters in place of copper sheet, hot mop and lead sheet waterproofing methods.

May be solvent welded to cover large areas. Note: Only **PASCO Vinyl Shower Pan Liner Solvent Cement #3008** may be used to solvent weld **PASCO Vinyl Shower Pan Liner**.

Limitations:

PASCO Vinyl Shower Pan Liner is to be concealed from sunlight when protection from water damage and long-term reliability is essential. This material cannot be exposed to outdoor elements.

Product Description:

Color: Red Thickness: 40 Mil

Color: Black Thickness: 30 Mil

Finish: Smooth Texture

Widths: Available in 48", 60", and 72" widths.

Lengths: Rolls come in lengths of 80 ft & 40 ft.

Markings: All **PASCO Vinyl Shower Pan Liner** is continuously marked with manufacturer's name, address, thickness, part number. Marked with IAPMO Listing # 2308 and ASTM D4551.

Technical Data:

PASCO Vinyl Shower Pan Liner is a flexible poly vinyl chloride sheet made of a virgin PVC resin containing no regrind material with an inherent viscosity of not less than 0.92 and a PVC compound density of between 1.26 g/cc and 1.29 g/cc.

Special Qualities:

- Requires no maintenance.
- Dramatic low temperature flexibility for easy installation in cold weather.
- Immune to mildew, fungus and bacterial degradation.
- Smooth surface to prevent snagging on metal lath.
- Lines every 6" for quick measurement.
- Easy to fold.
- Requires no special tools for installation.

Code Listings:

- IAPMO File #2308
- Copies of all code listings available upon request.
- Approved by many cities, counties and states including the City of Los Angeles (#RR4703).

Test Standard:

- Conforms to ASTM D4551 Test Standard.
- Meets FHA 1/30/63 test to determine suitability of materials for use as a shower pan.

Guarantee:

PASCO Vinyl Shower Pan Liner is guaranteed by **PASCO Specialty & Mfg., Inc.** against failure caused by rot, rust, cracks, electrolysis and microorganism deterioration in un-exposed installations if installed according to **PASCO Installation Instructions**.

This warranty is limited to replacement of the material and freight charges to destination only. There are no other express or implied warranties and this warranty is in lieu of any other warranty. **PASCO** is not responsible for consequential damages. The remedy of the purchaser set forth herein is exclusive.

For additional information, please call **PASCO** toll free: (800) 421-2053 or 800-737-2726



Need Help With Your Install?

PASCO has just the right tools to make your job easier!

“Big Red” Tape Measure

- Unbreakable Cicolac case
- Power return
- Belt clip
- Yellow tape
- Now Showing Fractions on tape



PART NUMBER	SIZES
3945	1" x 25'

Cellulose Sponges

- Excellent for drying and cleaning up
- For cleaning up tanks, lavatories, shower liners and leaking traps
- Yellow color

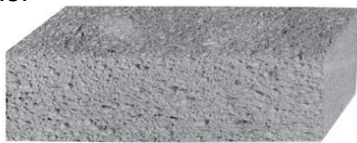

PART NUMBER	SIZES
5184	6" X 4-1/4" X 1-11/16"
5185	7-1/2" X 4-1/2" X 2-1/16"



Torpedo Level

- Magnet and grooved
- Sturdy die cast
- Colored liquid in vials



PART NUMBER
4472



Disposable Shoe Covers

- Non-skid sole
- Disposable
- 10 per pack



PART NUMBER
949

“Drop In” Half Barrel Type Caulking Gun

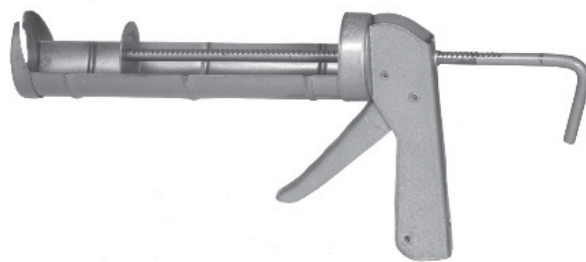

PART NUMBER
5100





Protective Knee Pads

- Comfortable
- Long lasting
- Codura nylon
- Foam rubber cushioning
- Flexible



#9221
Normal natural rubber cap prevents sliding and marring



#9220
White plastic cap allows user to swivel and slide on working surfaces

PART NUMBER	SIZES
9220	Hard protective cap
9221	Soft protective cap



Professional Wear-A-Day Disposable Gloves

- Blue, powder-free latex
- Plumber grade
- Sold by the box
- 50 per box
- 15 mil latex



PART NUMBER
952M
952L
952XL
952XXL

Disposable Gloves - Black

- Powder-free nitrile
- Sold by the box



PART NUMBER
950L
950XL

Atlas® Nitrile Tough Gloves - Black

- Grips
- Won't slip when wet
- Durable
- Resists solvent cement
- Packed 12 pair



PART NUMBER
370M
370L
370XL

Atlas® Nitrile 380 - Blue/Black

- Lint free nylon liner
- Compressed airinfused foam nitrile coating
- Waffle pattern provides good grip in wet conditions
- Heavy duty
- Packed 12 pair



PART NUMBER
380M
380L
380XL